



# VECTOR 2 RECESSED

Recessed Hard Ceiling

Client: \_\_\_\_\_  
Project Name: \_\_\_\_\_

Order #: \_\_\_\_\_  
Type: \_\_\_\_\_ Qty: \_\_\_\_\_

### Performance Data

#### CRI

95 min with R9 of 69 or better

#### CCT

2700K, 3000K, 3500K, 4000K,  
5 Channel Color Tuning

#### Projected Lifetime

240,000 Hours (L80);  
110,000 Hours (L90)

#### Dimming

0-10V dimming standard

#### Operating Temperature

-30°C to +55°C (-22°F to +131°F)

#### ETL Listed

Approved for dry and damp  
locations

#### Warranty

5 year Standard  
10 year Optional

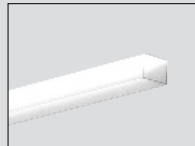

Drop Lens 1/2" or 2" (Direct)

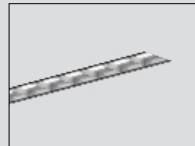

Louver (Direct)



### Description

The Vector 2 is a 2<sup>7</sup>/<sub>16</sub>" wide linear architectural luminaire. While the Vector has a slim and discreet profile, it provides excellent illumination for offices, laboratories, libraries, and commercial spaces. Vector is available in standard lengths of 2', 3', 4', 6', and 8', and can be joined together in seamless runs of any length in 1 foot increments.

### Features

#### PERFORMANCE

- Selected by IES for the 2017 Progress Report
- Up to 1200 lm/ft direct at 4000K

#### QUICKSHIP

- See page 3 for quickship part numbers

#### PHYSICAL

- Flanged luminaire: for Flangeless please order the Surface mount style

- Profile Dimensions: 2.95" wide x 4.6" high
- End Caps: Die cast aluminum with powder coat finish
- Housing: Extruded Aluminum with powder coat finish
- Direct Lens: Extruded Satin Acrylic
- Light Engine: Aluminum core LED board mounted to a white extruded chassis with integral driver and quick electrical disconnects for rapid tool-less servicing
- Weight: 30 pounds (8ft luminaire)

## V2R

## U



### Ordering Information

#### A FIXTURE SERIES

V2R Vector 2 Recessed

#### B LENGTH

2	2'
3	3'
4	4'
6	6'
8	8'
Sxxx	System <sup>1</sup>

#### C OUTPUT

L	7.5W/ft
M	10W/ft
H	15W/ft

#### D CCT

27	2700K
30	3000K
35	3500K
40	4000K
3W	3 Channel Tunable White <sup>2</sup>
5W	5 Channel Color Tuning <sup>2</sup>

#### E DIRECT LENS

—	Frosted <sup>7</sup>
C	1/2" Drop Lens
D	2" Drop Lens
L	Louver

#### F VOLTAGE

U	120-277V
---	----------

#### G FINISH<sup>5</sup>

W	Textured White
S	Textured Silver
B	Textured Black
##	Specialized Colors <sup>3,4</sup>
C	Textured Custom Colors

#### H OPTIONS

E	Emergency Battery Backup
T	Daylight Sensor <sup>6</sup>
M	Motion Sensor <sup>6</sup>
V	Daylight/Occupancy Sensor <sup>6</sup>

#### I CONTROLS

LE	LUTRON Ecosystem
LV	LUTRON VIVE
PE	PHILIPS Easysense
NL	nLight
EO	EnlightenedONE System <sup>7</sup>

#### J WARRANTY<sup>9</sup>

-	5 Year Warranty
10	10 Year Warranty
10L	10 Year Warranty including labor

- <sup>1</sup> Replace "xxx" with desired system length, in feet. See Continuous Run Guide for additional information (separate document)
- <sup>2</sup> Tunable CCT options only available at High Output setting. Controlled using DLM or DMX system (see Pages 4-5 for more info)
- <sup>3</sup> See below for Ordering Codes on 24 Specialized Finishes. Example "07"
- <sup>4</sup> Please Note: All orders under 25 linear feet will require a one-time set up charge. Please consult factory for charge.
- <sup>5</sup> All finishes are textured unless specified otherwise by the customer
- <sup>6</sup> Default sensor is the Enlighted One. See Page 6 for more information
- <sup>7</sup> See Page 6 for more information
- <sup>8</sup> Fixture standard
- <sup>9</sup> 5 Year Warranty is Standard unless specified

**Dimensions**

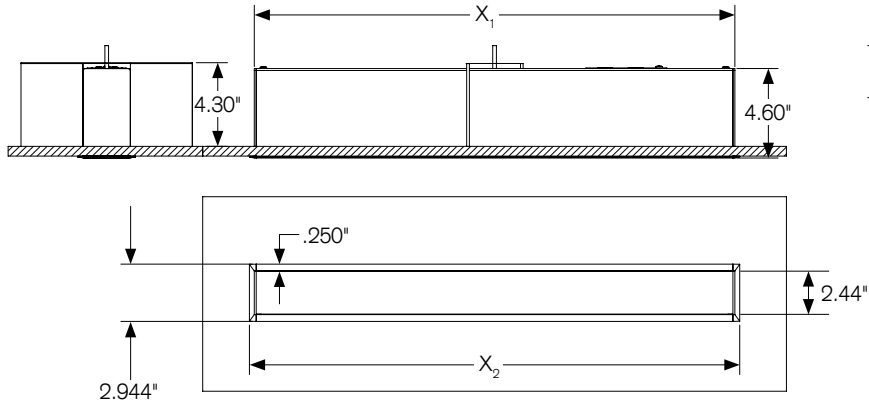

	2	3	4	6	8
X <sub>1</sub>	24.2"	36.2"	48.2"	72.2"	96.2"
X <sub>2</sub>	24.7"	36.7"	48.7"	72.7"	96.7"

**Specialized Colors**

**A-Classic**

	01	Natural Aluminum	RAL #7035
	02	Silver Bullet	RAL #7038
	03	Raven	RAL #9005
	04	Crystal White	RAL #9010
	05	Macademia	RAL #9003
	06	Hampden	RAL #9001
	07	London	RAL #7044

**B-Urban**

	08	Urban Native	RAL #8025
	09	Military Green	RAL #6011
	10	Carmin	RAL #8028
	11	Chocolate Spice	RAL #8017
	12	Asher Grey	RAL #7004
	13	Tech Grey	RAL #7016
	14	Slate	RAL #7031
	15	Mason	RAL #7039

**C-Fresh**

	16	Violet Dreams	RAL #4006
	17	Sangria Sunset	RAL #2004
	18	Deep Pink	RAL #4010
	19	Ruby Red	RAL #3027
	20	Island Skye	RAL #6027
	21	Sophia	RAL #5015
	22	Antique Spring	RAL #6019
	23	Daisy	RAL #1018
	24	Gun Metal	RAL #7024

Please Note: All orders under 25 linear feet will require a one-time set up charge. Please consult factory for charge.

**Photometrics**

Polar Graph - 4' High Output 4000K

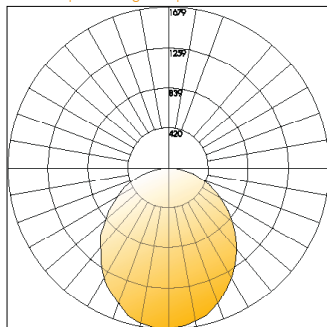

Delivered Lumens: 4640  
CRI: 97

**Direct (Down) Lumen Chart:**

OUTPUT SELECTION	LOW	MEDIUM	HIGH
NOMINAL WATTAGE	7.5W/ft	10W/ft	15W/ft
LUMENS PER FOOT	570	855	1160
<b>2' LENGTH</b>			
System Wattage	12.00	18.00	24.00
Lumen Output	1140	1700	2320
<b>3' LENGTH</b>			
System Wattage	18.00	27.00	36.00
Lumen Output	1710	2550	3480
<b>4' LENGTH</b>			
System Wattage	24.00	36.00	49.00
Lumen Output	2280	3400	4640
<b>6' LENGTH</b>			
System Wattage	36.00	54.00	72.00
Lumen Output	3420	5100	6960
<b>8' LENGTH</b>			
System Wattage	48.00	72.00	96.00
Lumen Output	4560	6800	9280

Lumen values shown are for 4000K models. For other color temperatures, use the below multipliers: 2700K: 0.85, 3000K: 0.90, 3500K: 0.95

For total system wattage consumption and lumen output, add the direct and indirect lumen and wattage data based on output settings desired.

**EX: V2R-4-F-40-F-U-E-LE**

	Direct	Total
Wattage	49.00	73.00
Lumen	4640	7520

**Continuous Runs**

When a system run is ordered, individual sections are shipped, labeled with their Section of Run noted at the end of the part number. Shown below is an example of a 13' continuous run. For more information, refer to the continuous run guide.

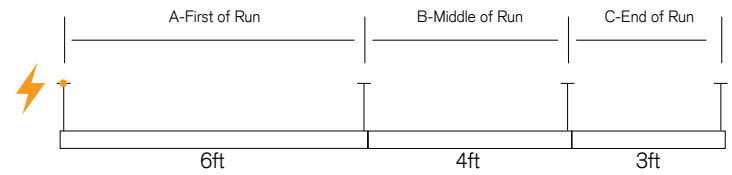

**Quickship**

PART NUMBER	DESCRIPTION
V2R4MSBUW	V2 Recessed 4', Med. Output Switch Board Down (30K-40K), 120-277V, White
V2R8MSBUW	V2 Recessed 8', Med. Output Switch Board Down (30K-40K), 120-277V, White

**Lens Accessories**

Drop Lens (Direct)  
Available in 1/2" and 2"

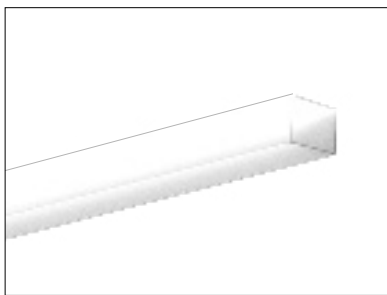

A white frosted PMMA lens that protrudes from the luminaire housing by 0.5" or 1.5" End caps are chemically welded to the lens.



Louver (Direct)

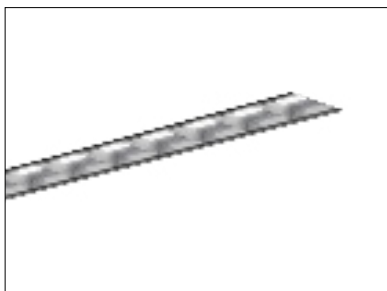

A Semi-specular parabolic louver. 22 GA. Aluminum Louver depth 3/4" louver spacing 2" Provides excellent glare control.



# DECO SPECTRUM™ WHITE

## 3-Channel Tunable White Circadian Rhythm-based Illumination

Deco Spectrum™ White is a three-channel tunable white solution delivering a wide range of color temperatures precisely along the blackbody curve to replicate natural daylight. This new introduction to the Vector series combines precision dimming with human-centric tunable white illumination aimed to more accurately follow the body's circadian rhythm than static white luminaires. This system is an ideal solution for healthcare, education, and office applications seeking to better tailor lighting to the evolving needs of their clients and customers.

The benefits of Deco Spectrum™ White include:

- Both lumen and color maintenance ensure consistent light output throughout the life of the fixture
- The Architectural Dimming control system delivers precise dimming via DMX for both tunable white and color applications with fixed and mobile user interfaces
- 90+ CRI throughout entire tunable CCT range
- On-Planckian tuning from a warm 2700K to cool 6500K
- Delivers the highest possible quality of tunable white light currently available, replicating the visual comfort of natural daylight.

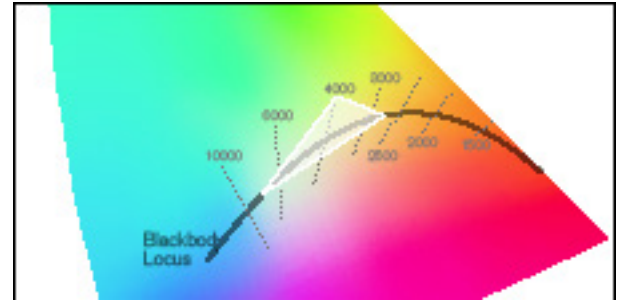

Three White LEDs Tunable range is within the white shaded gamut. (2700K – 6500K)



2700K



3500K



6500K

### Connection

Sample Connection Diagram with 3W Fixtures

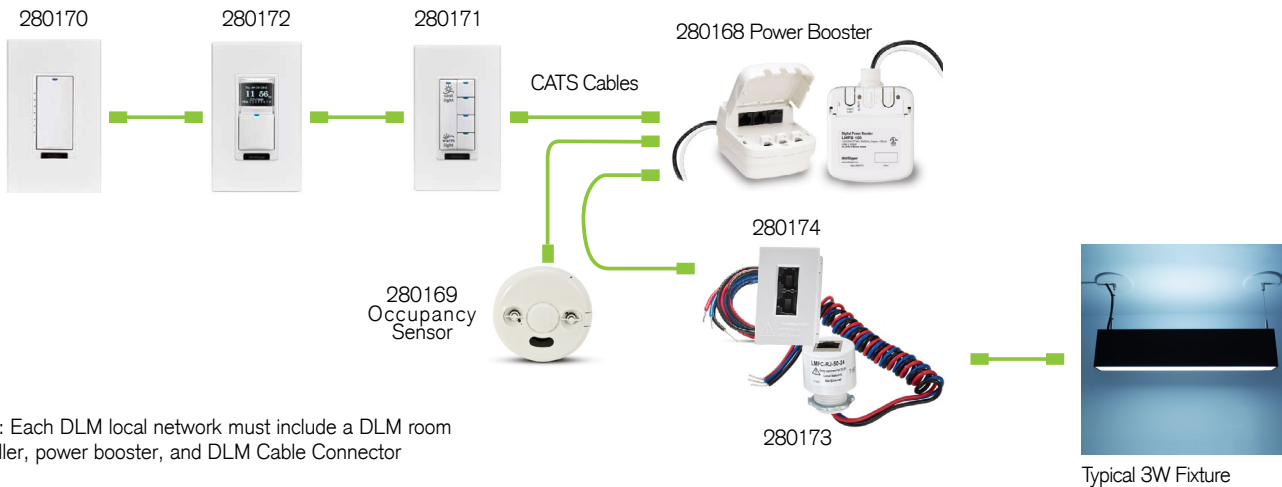

NOTE: Each DLM local network must include a DLM room controller, power booster, and DLM Cable Connector

### Parts

- 280168-** DLM Power Booster -Conduit Mount -120-277VAC
- 280169-** Occupancy Sensor
- 280170-** DLM Digital Dimming Wall Switch - White
- 280171-** DLM Digital Color Preset Switch - White
- 280172-** DLM Digital Color Control Schedule Switch - White
- 280173-** DLM Cable connector whip with one RJ45 port and 24" leads; fits 1/2" KO
- 280174-** DLM Cable connector whip with two RJ45 port and 24" leads; fits rectangular Opening

# DECO SPECTRUM™ COLOR

## 5 Channel Color Tuning

Deco Spectrum™ Color mixes five different colors of high brightness, broad spectrum LEDs – none of which are white – to deliver light that is 2 MacAdam ellipses about the Planckian curve at 90+ CRI across the tuning range. The result: light that accurately depicts – across the full tuning range – the object's color as compared to its color in true sunlight.

The number of control channels deployed in a color tuning system impacts the quality of the light and consistency of color. It also affects the color tuning range, the level of gamut control and the efficacy of the solution.

The benefits of Deco Spectrum™ Color include:

- Perfectly natural white light.
- On-Planckian tuning from 1650K to 8000K.
- Dimming from 100% to 1% while maintaining CCT, or variable CCT from 3050K down to 1800K to match traditional incandescent or MR-16 lamp dimming
- Industry-leading color rendering (Ra) greater than 90, throughout the tuning range.
- Gamut control for unlimited control and customization of lighting design using the Saturation and Hue controls.
- Consistent color of 2 SDCM about the Planckian Curve over the life of the module.
- Deco 5 Channel Color Tuning must be controlled using DMX protocol only.

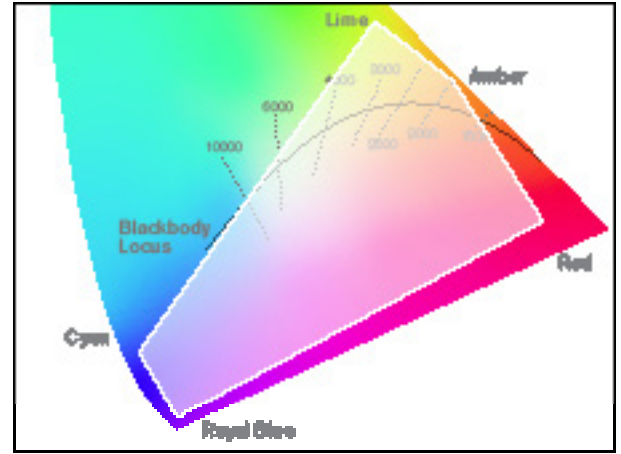

Five Color LEDs (1650K – 8000K) Tunable range is within the white shaded gamut. With Deco Spectrum™ you can go off the curve to change saturation and hue.

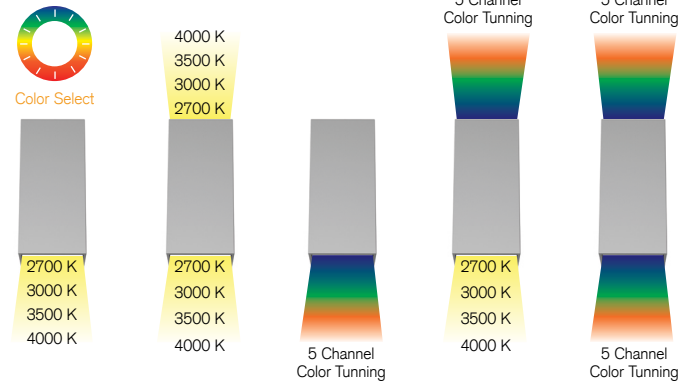
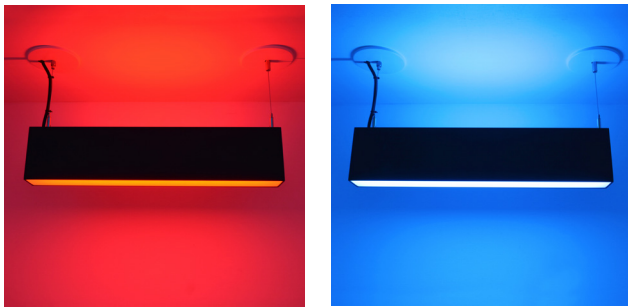

## Example Control Options



SM-8 (SM-8)

The SM-8 is a Wall-Mounted DMX Controller with 8 preset static lighting scenes.



STICK (280188)

The STICK is a Wall-Mounted Smart DMX Controller with USB and Ethernet connectivity. Users can load multiple zones with static and transient scenes, and attach photos to each scene that will appear on the LCD screen.

## Enlighted Micro Sensor

### Overview

The Micro Sensor is a complete sensing and lighting control node powered from its attached light fixture. An innovative carrier-based mounting design supports easy installation and replacement. With integrated wireless communications for data transmission and remote configuration as well as autonomous fixture-level control, this sensor brings advanced lighting automation to a whole new level.

The Enlighted Micro Sensor				The Enlighted Fixture Carrier			
Body	L	0.88"	22.5mm	Body	L	0.51"	13 mm
	Dia	0.73"	18.5 mm		Dia	0.81"	20.7 mm
Bezel	Dia.	1.06"	27.0 mm	---	---	---	---

### Features and Benefits

#### Bluetooth Low Energy:

An embedded BLE radio allows the sensor to receive and transmit beacons as well as support communication with lighting control devices and other sensors.

#### Enlighted Sensor Interface (ESI):

IoT Ready™ LED drivers and Enlighted Control Units communicate with the sensor directly via a serial interface. The ESI provides access to device information, energy consumption, and digital lighting control.

#### Localized Lighting Control:

Light-level schedules, preferences, and behavior profiles for each fixture are wirelessly communicated during system setup and locally stored to ensure continuous operation.

#### Driver Compatibility:

Dimming and on/off control signaling for standard 0-10V ballasts and drivers in LED and fluorescent light fixtures.

#### Standards-Based Networking and Security:

The Enlighted 802.15.4 wireless network with AES-128 encryption delivers secure, reliable communication that coexists with Wi-Fi networks by sensing low-traffic channels and transmitting in bursts.

#### Occupancy and Thermal Sensing:

A digital Passive Infrared (PIR) sensor combined with separate ambient and temperature sensing support precise motion identification while minimizing false detection events.

#### IoT Sensing Node:

When configured as an IoT Node, the sensor streams comprehensive live data for use with Enlighted's real-time location and analytics software applications. This option is available directly from the factory or as a remote upgrade.

#### Daylight Harvesting:

Captured ambient light information is locally processed to raise and lower light levels based on available daylight.

#### Edge Sensing:

Local processing capability supports advanced sensing and detection algorithms, providing optimization of existing features and enabling future applications.

#### Room and Zone Control:

Pairs with room control switches for code-compliant manual-on or auto-off capability. Sensors can be grouped into zones that share occupancy sensing data and coordinate light control based on detected motion.



### Mounting

The Enlighted Micro Sensor is designed to be easily mounted into lighting fixtures or ceiling tiles such that only the discreet white faceplate is visible. The sensor slides into a carrier sleeve fitting a standard 1/2 inch trade size knockout or 7/8 inch (22 mm) hole. Carrier sleeves compatible with either lighting fixtures or ceiling tiles are available. Sensor replacement requires no tools—simply slide the sensor out of the carrier, unplug the connector, and install the new sensor.

Micro Sensor

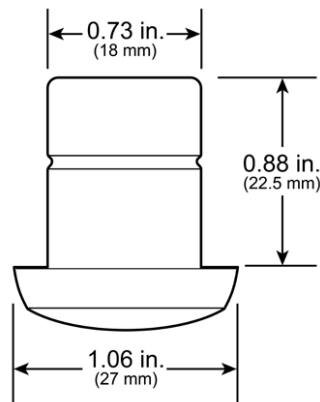

Carrier

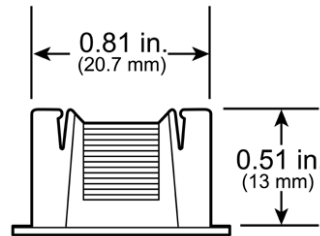

**Smart Controls**

The Vector is compatible with a variety of advanced sensor solutions from Phillips, Lutron, Enlighted, and Osram, to name just a few. Smart sensors are an ideal add-on for those seeking additional functional benefits and even deeper energy savings over traditional fluorescent systems. Smart sensors increase the versatility of the Vector, transforming the way in which the luminaire adapts to the needs and behaviors of inhabitants within a space to create a smart building solution that marries design with function.

**DECO MESH**

Utilizing Bluetooth Smart® technology, light fixtures interact directly with smartphones, without the need of a bridge or complex setup. Luminaires can be operated in public mode, giving access to everyone, or private mode, restricting access to select individuals.



nLight® is a networked digital lighting control solution that delivers energy savings and increased user configurability by combining time-based, daylight-based, sensor-based and manual lighting control schemes. With this protocol the Vector has the NCMB 9 In-fixture sensor installed into the fixture.

**PHILIPS**

Phillips sensor solutions are designed for applications that include retail and hospitality, office spaces, public areas, and education. Offering devices that combine motion detection, light level assessment, and dimming into single units, Phillips delivers a system for sophisticated yet simple lighting control. When this protocol is selected the Vector has PHILIPS drivers installed and wired, ready to connect to your ecosystem. No sensors are included.

**enlighted**

Patented, software-defined smart sensor solution that tracks real-time occupancy, light levels, ambient temperature and energy usage, along with other data points. Enlighted sensors can distinguish between people and objects, customize controls for specific tasks, leverage ambient light provide unmatched coverage for data collection.

**LUTRON**

Utilizing the proprietary EcoSystem® communications protocol, Lutron provides a two-way digital network that incorporates motion sensing, daylight harvesting, occupancy/vacancy sensing, and high performance dimming functionality. When this protocol is selected the Vector has Lutron drivers installed and wired, ready to connect to your ecosystem. No sensors are included.



A modular wireless lighting control system utilizing Lutron-patented and proven RF protocols designed for new and existing buildings. Vive System wireless solutions are well-suited for K-12 schools, commercial and government offices, and university campuses where the customer is looking to meet basic code requirements while enabling simple commissioning, operation & reporting via IoT capable smart devices. When this protocol is selected the Vector has Lutron drivers and the VWSD Lutron Vive Wireless Fixture (Integral RF w/Occ & Daylight Sensor) installed. Alternatively, the VWO Powpack can be purchased and installed separately.

**legrand** WATTSTOPPER®

Wattstopper offers a comprehensive line of simple, scalable and flexible energy efficient lighting controls and solutions for commercial and residential spaces with a mix of digital lighting management built on occupancy, plug load, and daylighting controls. Currently the 3W version of the Vector is the only version ready to use out of the box with Legrand protocols.

Smart Sensors	Protocol	Compatible Networks*	Occupancy	Daylight	Temperature Reporting	Communication to Luminaire
DECO MESH	BLF Blue Tooth Low Energy	DECOMesh	Enabled	Enabled	No	Wired
nLIGHT	nLight	nLight	Enabled	Enabled	No	Wired
enlighted	Enlighted RF	Enlighted RF	Integrated	Integrated	Yes	Wireless
legrand WATTSTOPPER®	DLM	DLM	Enabled	Enabled	No	Wired
LUTRON	EcoSystem	Quantum, Energi Savr Node, Energi TriPak	Enabled	Enabled	No	Wired
vive	Lutron Clear Connect®	Lutron Vive System Network	Enabled	Enabled	No	Wireless
PHILIPS	ZigBee HA	Philips	Enabled	Enabled	No	Wired

\*Not all compatible networks may be listed.