



Client: _____ Order #: _____
Project Name: _____ Type: _____ Qty: _____

D421-LED

14" Decorative Round Luminaire

Performance Data

CRI

80+

CCT

4000K, 5000K

Projected Lifetime

100,000+ Hours (L70)

Dimming

0-10V dimming standard,
100% down to 10%

Operating Temperature

-40°C to +50°C Ambient



10 Yr	USA
Warranty Including Labor	Buy American Act Compliant

Description

The 14" round decorative luminaire is designed for durability and performance to withstand today's toughest environments, including schools, parking garages, office complexes and any other application prone to vandalism.

Features

- Replaces up to 100W HPS or MH fixtures
- Die-cast aluminum front frame & housing, nickel-plated stainless steel hardware
- Housing finish is textured powdercoat paint over a chromate conversion coating
- Available with open, cross/grid, or eyelid guard styles
- The deep casting is provided with 4 .5" threaded conduit coin plugs.
- Polycarbonate opal lens eliminates LED hot spots/pixelation
- Type IV light distribution
- System Wattage: 19.7 watts

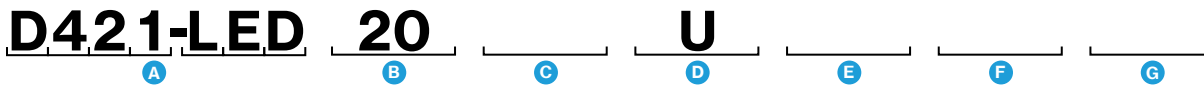

Ordering Information

A FIXTURE SERIES

D421-LED 14" Decorative Round Luminaire

B WATTAGE/LUMENS

20 20W/1674³

C CCT

40 4000K
50 5000K

D VOLTAGE

U 120-277V

E GUARD

O Open
C Cross
E Eyelid

F FINISH

BZ Bronze¹
WH White
CU Custom²

G OPTIONS

SP Surge Protection
PC1 Photocell (120V)
PC2 Photocell (277V)
EM Emergency Battery
S2 Microwave Sensor w/Dimming⁴

¹ Standard for fixture

² Contact factory for custom finish

³ Delivered Lumens (5000K)

⁴ Designed for Mounting Heights of 15ft or less

Dimensions

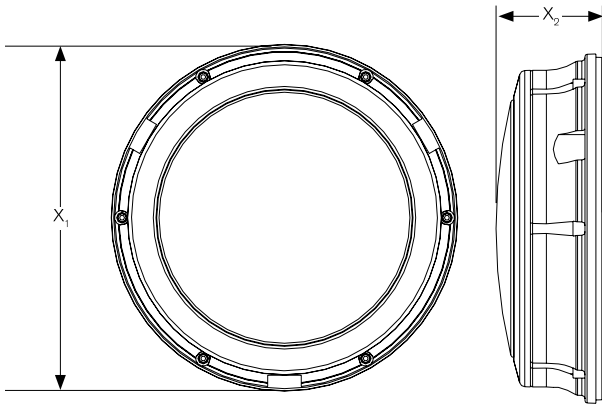

	Inches		
	Open	Cross	Eyelid
X ₁	12.50	12.50	12.50
X ₂	3.94	4.38	12.50

Photometrics (Open Guard)

Model 20W 5000K

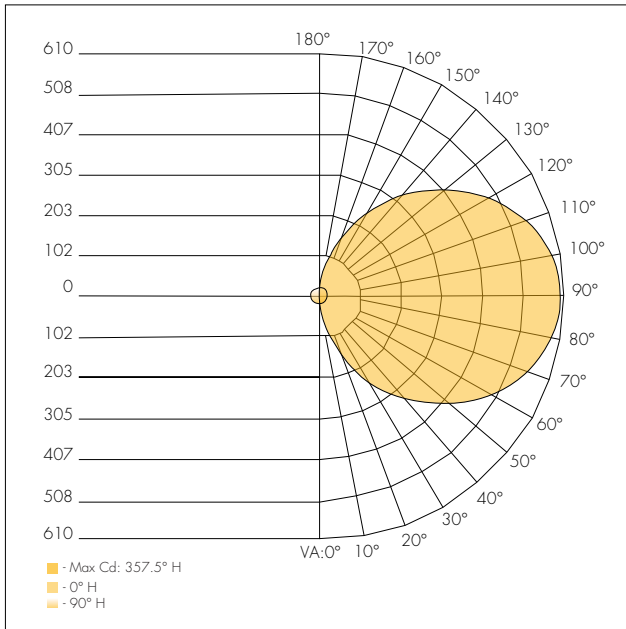

Isofootcandle

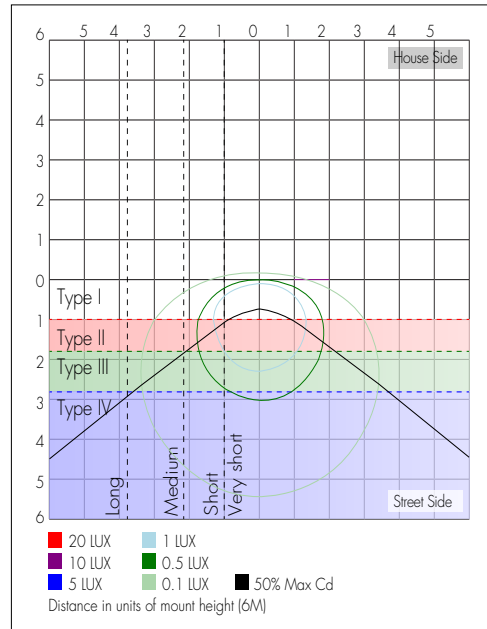

Zonal Lumen Summary

Zone	Lumens	%Luminaire
0-30	44.9	2.7%
0-40	102.5	6.1%
0-60	317.1	18.9%
60-90	530.1	31.7%
70-100	566.6	33.8%
90-120	523.2	31.2%
0-90	847.2	50.6%
90-180	827.3	49.4%
0-180	1,674.5	100%

Photometrics (Cross Guard)

Model 20W 5000K

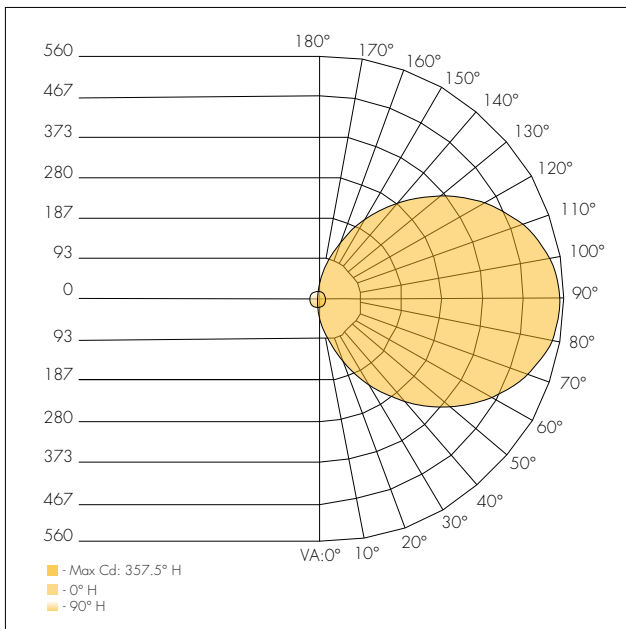

Isofootcandle

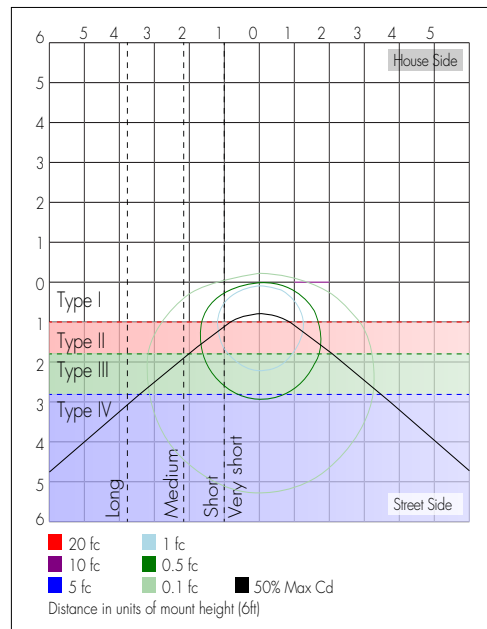

Zonal Lumen Summary

Zone	Lumens	%Luminaire
0-30	39.5	2.7%
0-40	90.2	6.1%
0-60	281.2	19.2%
60-90	471.6	32.1%
70-100	502.6	34.2%
90-120	459.1	31.3%
0-90	752.8	51.3%
90-180	715.4	48.7%
0-180	1,468.1	100%

Photometrics (Eyelid Guard)

Model 20W 5000K

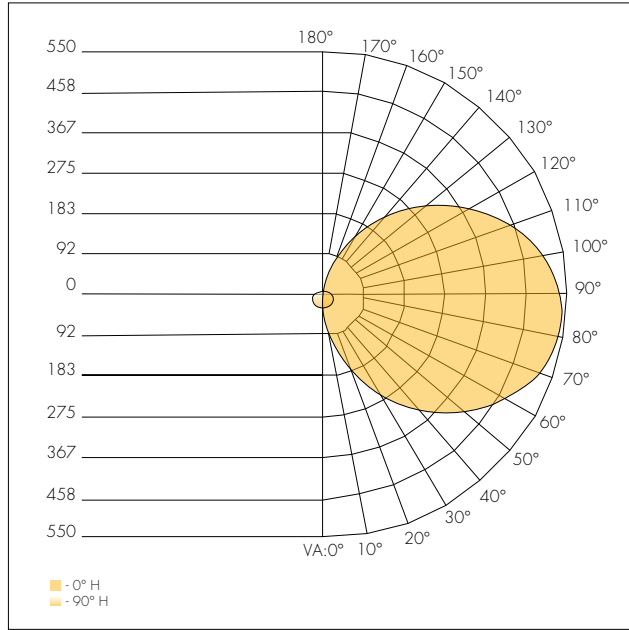

Isofootcandle

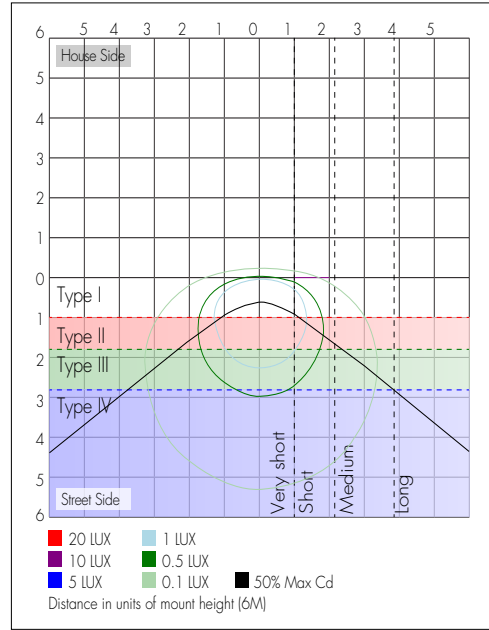

Zonal Lumen Summary

Zone	Lumens	%Luminaire
0-30	55.6	3.8%
0-40	118.6	8.1%
0-60	336.0	22.9%
60-90	492.9	33.6%
70-100	510.5	34.8%
90-120	437.2	29.8%
0-90	828.8	56.5%
90-180	637.9	43.5%
0-180	1,466.7	100%

Guard Options



Cross



Eyelid

LED Battery Backup

- Provides 90 mins of backup power.
- 100-277/50-60Hz Input Voltage
- Operation Temp Range: 0°-50°C
- Green LED Indicator for Stand-by Mode
- Optional Test Switch
- Short-Circuit, Overload, and No Load Protection
- Low Battery Shutdown to Protect Battery From Deep-Discharging
- RoHS Compliant

