

CONTINUOUS RUN GUIDE

This document explains how runs are constructed

providing samples of continuous runs of 9 feet up to 50 feet in one foot increments

Longer runs can be constructed based on logic provided

WALL MOUNT MOUNTING DIMENSIONS

Minimum length for wall mount runs are in 2ft increments with addition of necessary end caps.

- Wall mount fixtures arrive with pre-mounted brackets that easily attach to additional brackets which will need to be installed.

1.

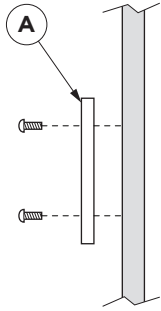

2.

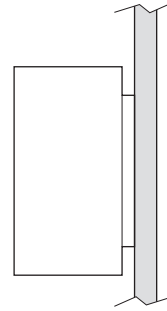
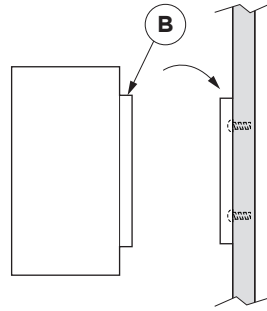

ONE



TWO



THREE

Wall Mount Standard Lengths



WALL MOUNT MOUNTING DIMENSIONS

Vector 1, Vector 3

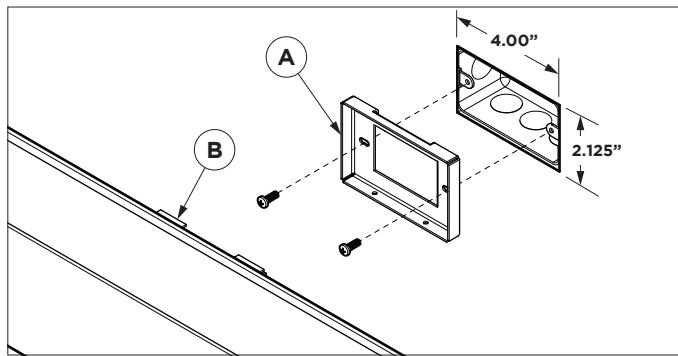
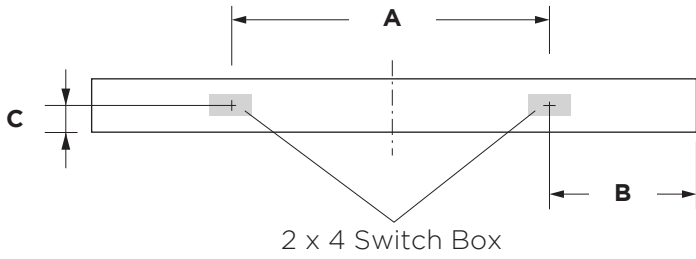

Vector 2

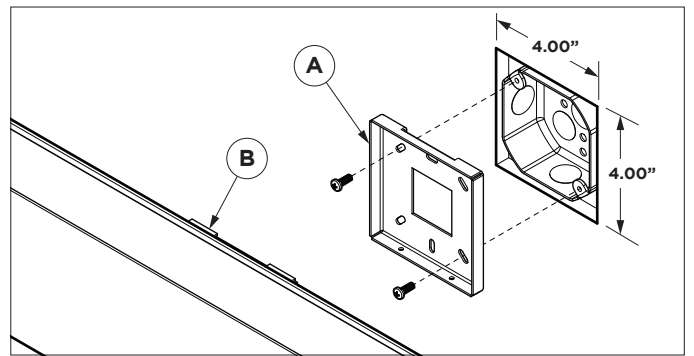
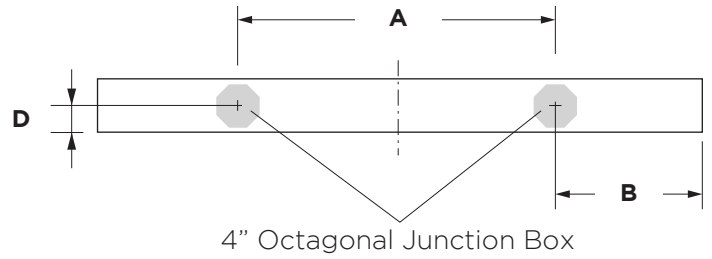

	2 ft	3 ft	4 ft	6 ft	8 ft
A	16.00" 406.4mm	16.00" 406.4mm	32.00" 812.8mm	32.00" 812.8mm	64.00" 1625.6mm
B	4.00" 101.6mm	10.00" 254.0mm	8.00" 203.2mm	20.00" 508.0mm	16.00" 406.4mm
C	2.50" 63.5mm	2.50" 63.5mm	2.50" 63.5mm	2.50" 63.5mm	2.50" 63.5mm
D	3.10" 78.74mm	3.10" 78.74mm	3.10" 78.74mm	3.10" 78.74mm	3.10" 78.74mm

WALL MOUNT FOUR TYPES OF SEGMENTS

Continuous runs are created in one foot increments using four types of standardized luminaire segments.

#1 - STANDALONE luminaires arrive complete, ready to install and use

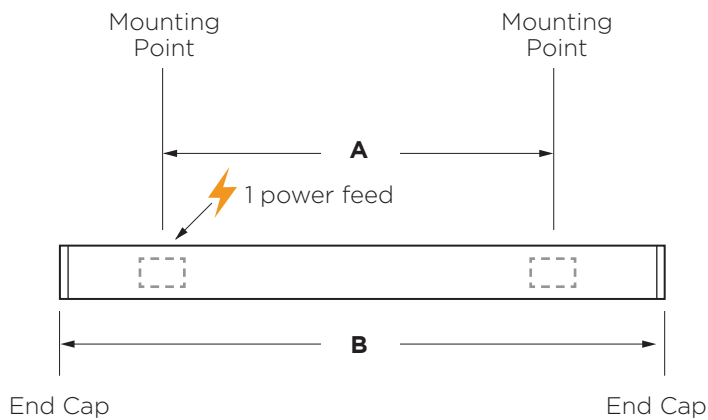

	2 ft	3 ft	4 ft	6 ft	8 ft
A	16" 406.4mm	16.00" 406.4mm	32.00" 812.8mm	32.00" 812.8mm	64.00" 1625.6mm
B	24.32" 617.728mm	36.32" 922.528mm	48.32" 1227.328mm	72.32" 1836.928mm	96.32" 2446.528mm

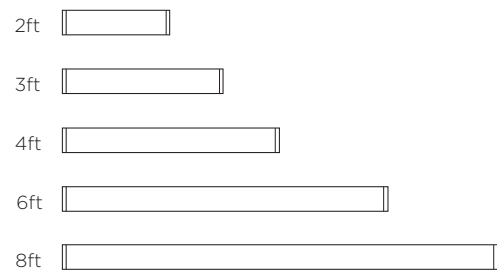

Standalone Standard Lengths

#2 - FIRST OF RUN

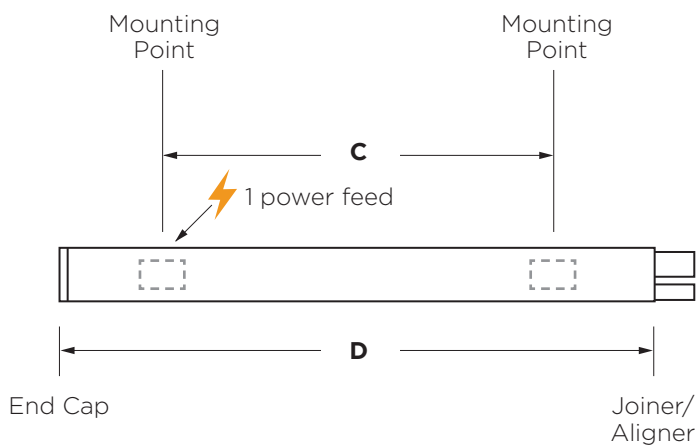

	2 ft	3 ft	4 ft	6 ft	8 ft
C	X	X	X	32.00" 812.8mm	64.00" 1625.6mm
D	X	X	X	72.16" 1832.864mm	96.16" 2442.464mm

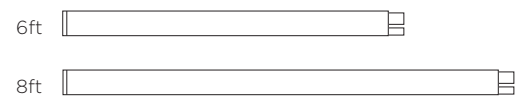

First of Run Standard Lengths

WALL MOUNT FOUR TYPES OF SEGMENTS

Continuous runs are created in one foot increments using four types of standardized luminaire segments.

#3 - MIDDLE OF RUN

Each fixture is supported by the wall mount brackets.

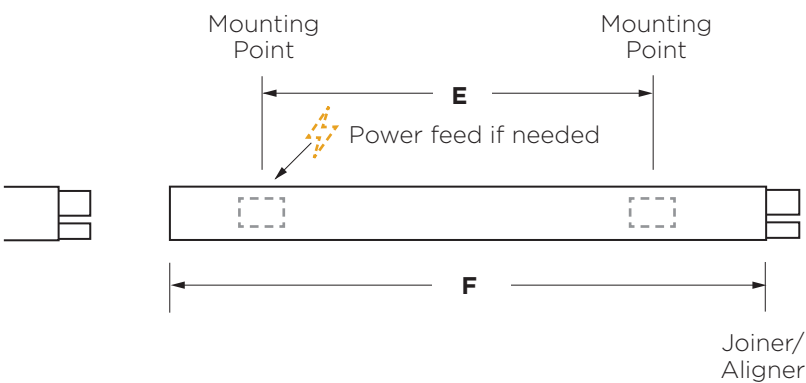

	2 ft	3 ft	4 ft	6 ft	8 ft
E	X	X	32.00" 812.8mm	32.00" 812.8mm	64.00" 1625.6mm
F	X	X	48" 1219.2mm	72" 1828.8mm	96" 2438.4mm

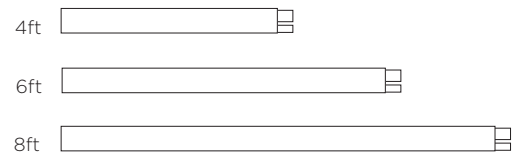

Middle of Run Standard Lengths

#4 - END OF RUN

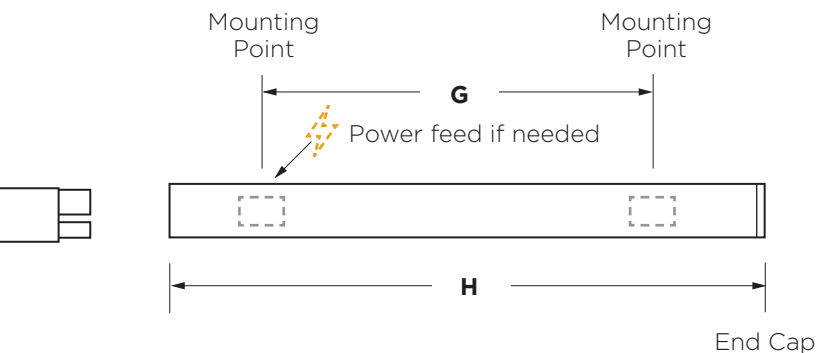

	2 ft	3 ft	4 ft	6 ft	8 ft
G	X	16.00" 406.4mm	32.00" 812.8mm	32.00" 812.8mm	64.00" 1625.6mm
H	X	36.16" 918.464mm	48.16" 1223.264mm	72.16" 1832.864mm	96.16" 2442.464mm

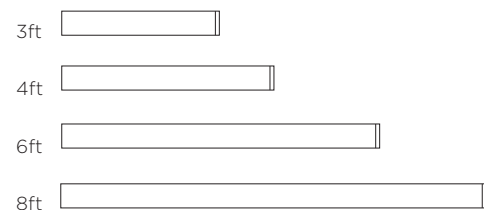

End of Run Standard Lengths

CONTINUOUS RUN GUIDE

⚡ A single power drop can run up to 28 ft (120 VAC) and 64 ft (277 VAC)

9' fixture

107.35"
2726.69mm

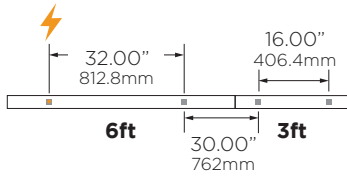

10' fixture

119.35"
3031.49mm

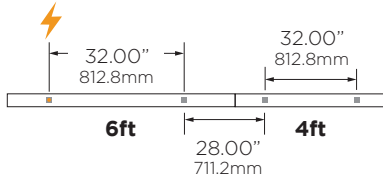

11' fixture

131.35"
3336.29mm

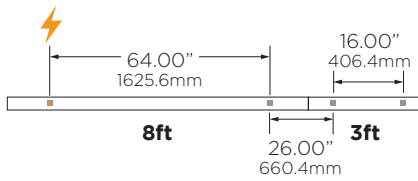

12' fixture

143.35"
3641.09mm

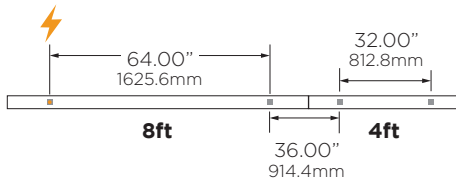

13' fixture

155.35"
3945.89mm

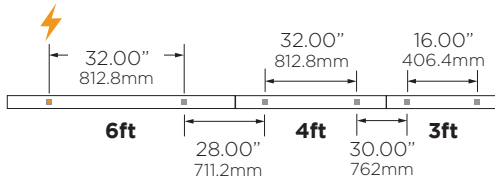

14' fixture

167.35"
4250.69mm

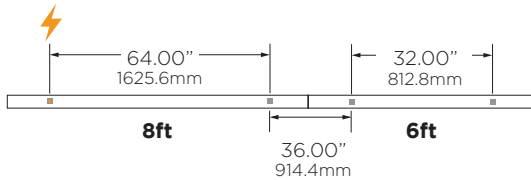

15' fixture

179.35"
4555.49mm

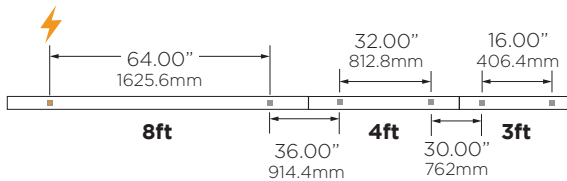

16' fixture

191.35"
4860.29mm

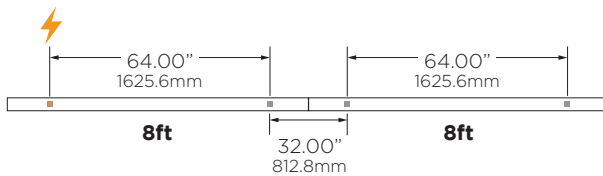

17' fixture

203.35"
5165.09mm

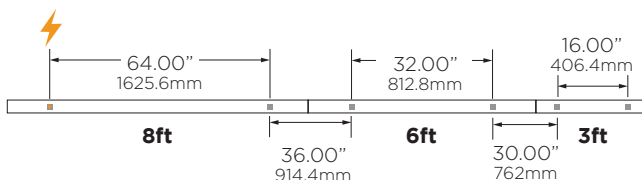

CONTINUOUS RUN GUIDE

18' to 26' Run Configurations

⚡ A single power drop can run up to 28 ft (120 VAC) and 64 ft (277 VAC)

18' fixture

215.35"
5469.89mm

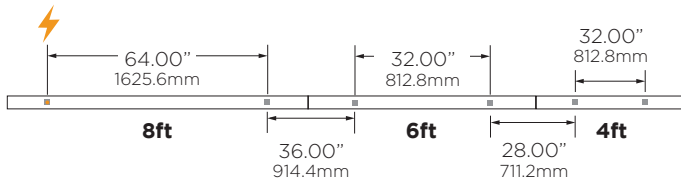

19' fixture

227.35"
5774.69mm

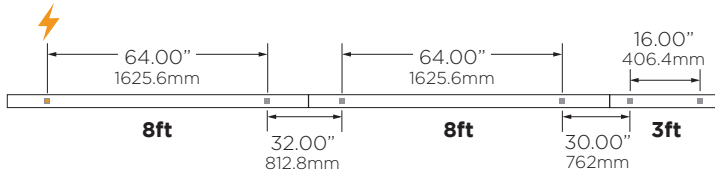

20' fixture

239.35"
6079.49mm

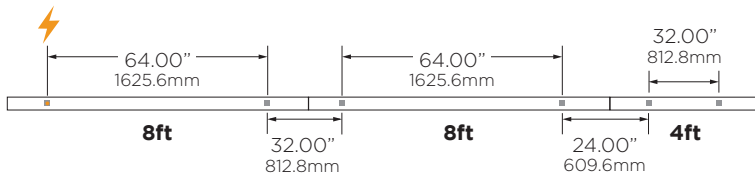

21' fixture

251.35"
6384.29mm

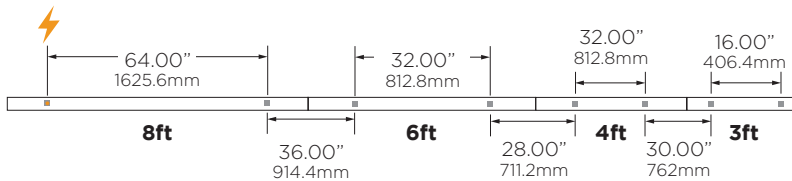

22' fixture

263.35"
6689.09mm

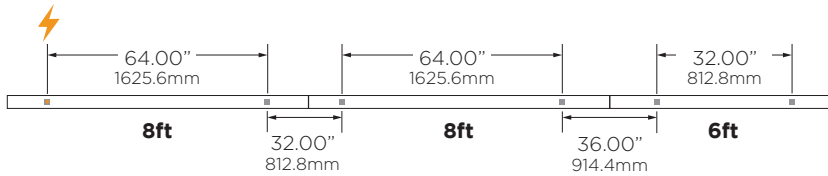

23' fixture

275.35"
6993.89mm

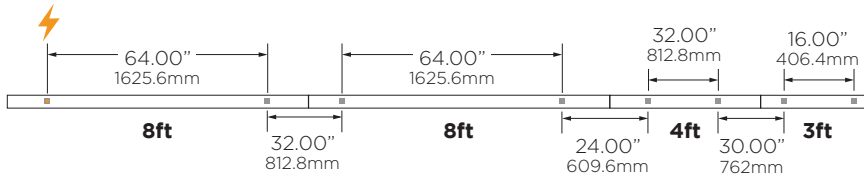

24' fixture

287.35"
7298.69mm

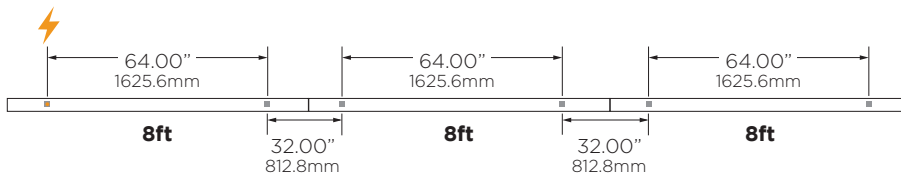

25' fixture

299.35"
7603.49mm

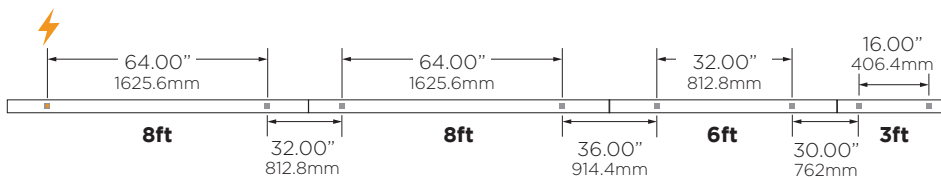

26' fixture

311.35"
7908.29mm

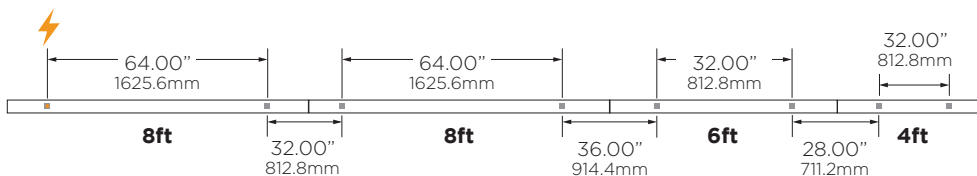

CONTINUOUS RUN GUIDE

⚡ A single power drop can run up to 28 ft (120 VAC) and 64 ft (277 VAC)

27' fixture

323.35"
8213.09mm

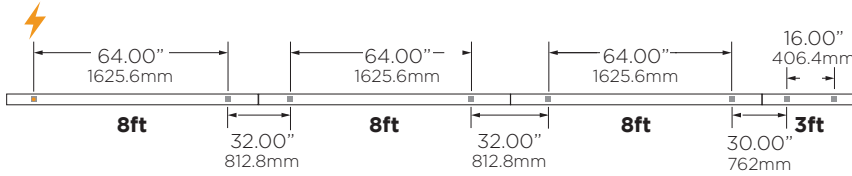

28' fixture

335.35"
8517.89mm

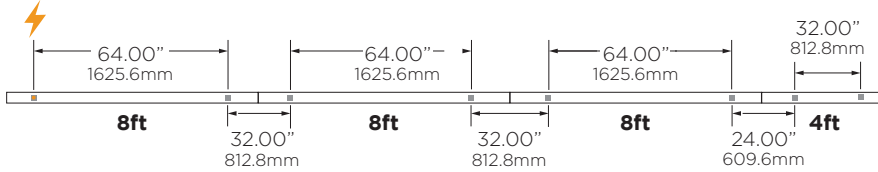

29' fixture

347.35"
8822.69mm

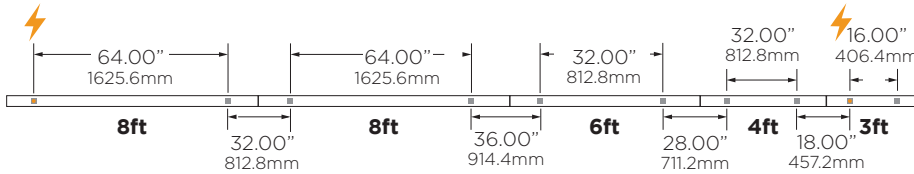

30' fixture

359.35"
9127.49mm

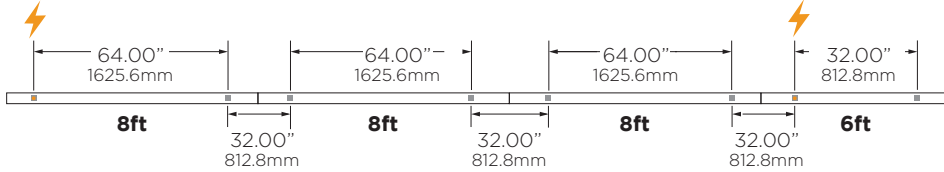

31' fixture

371.35"
9432.29mm

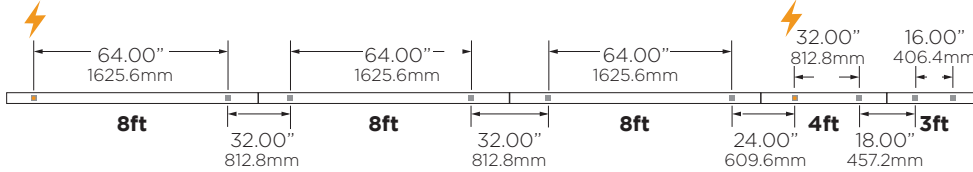

32' fixture

383.35"
9737.09mm

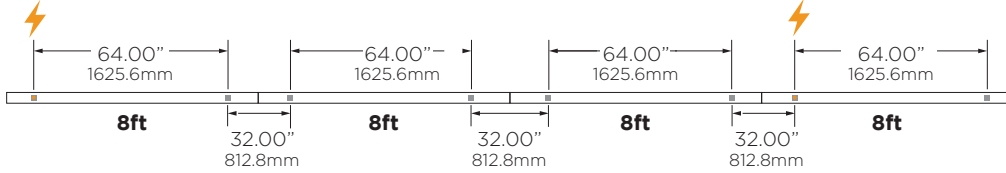

33' fixture

395.35"
10041.89mm

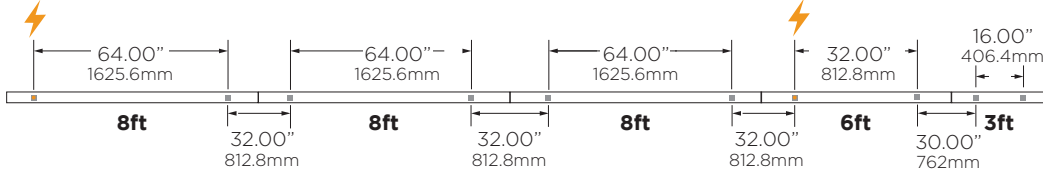

34' fixture

407.35"
10346.69mm

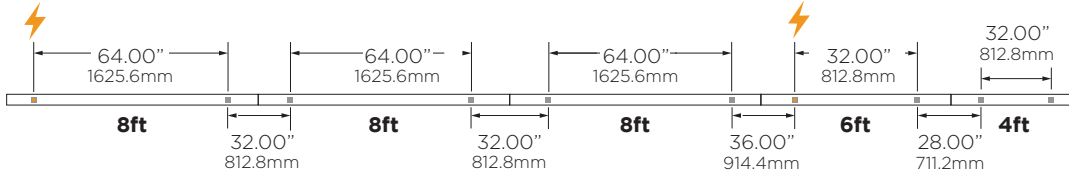

35' fixture

419.35"
10651.49mm

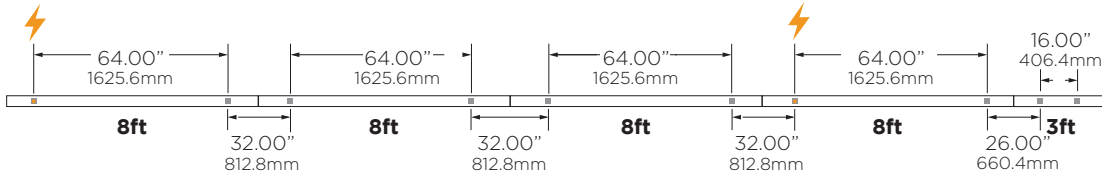

CONTINUOUS RUN GUIDE

⚡ A single power drop can run up to 28 ft (120 VAC) and 64 ft (277 VAC)

36' fixture

431.35"
10956.29mm

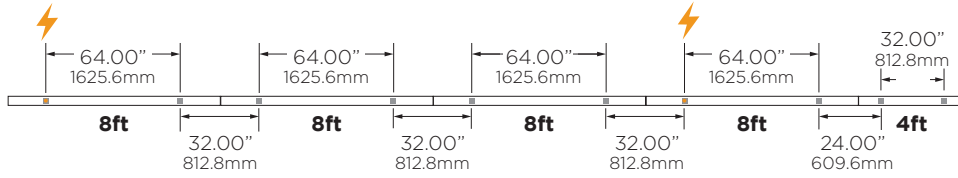

37' fixture

443.35"
11261.09mm

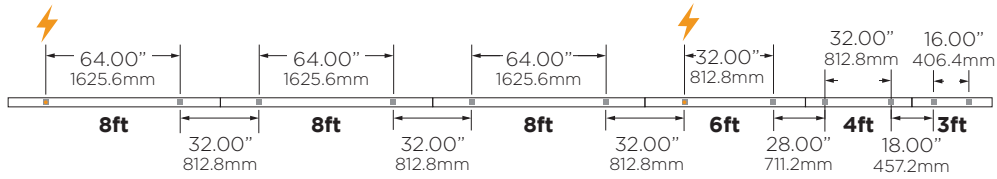

38' fixture

455.35"
11565.89mm

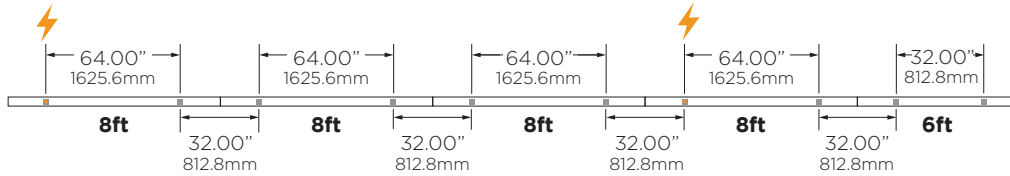

39' fixture

467.35"
11870.69mm

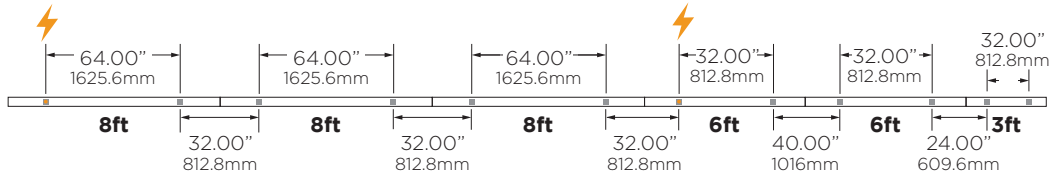

40' fixture

479.35"
12175.49mm

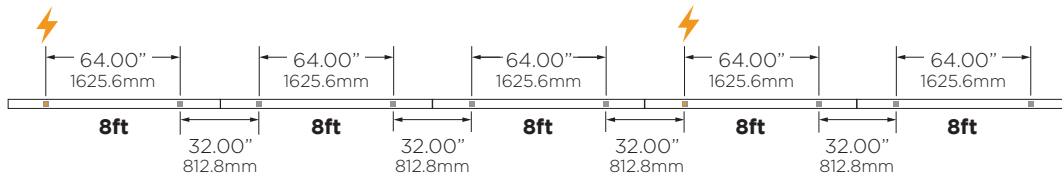

41' fixture

491.35"
12480.29mm

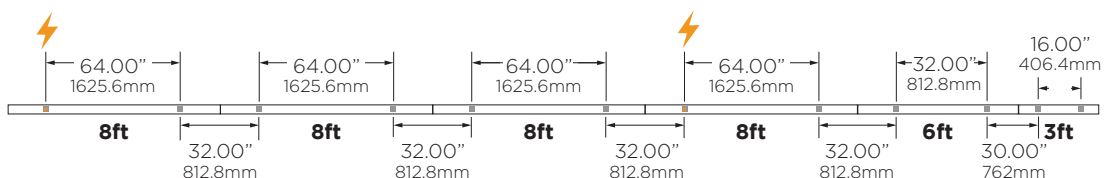

42' fixture

503.35"
12785.09mm

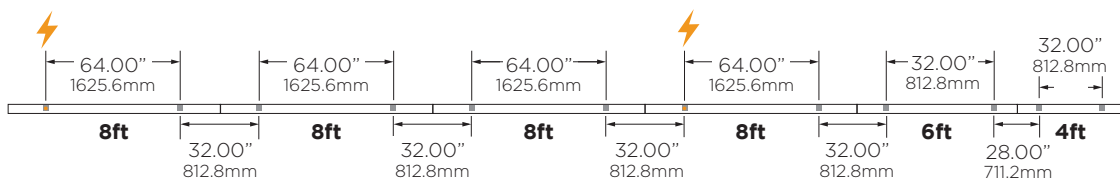

43' fixture

515.35"
13089.89mm

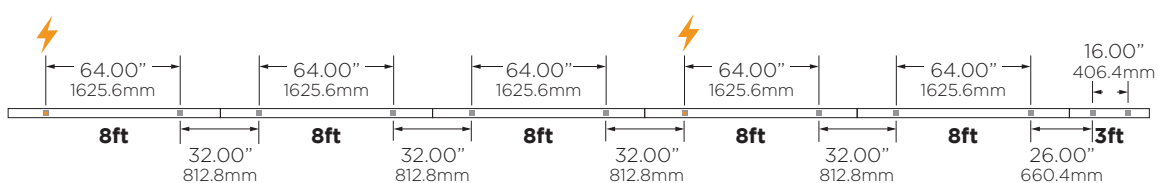

44' fixture

527.35"
13394.69mm

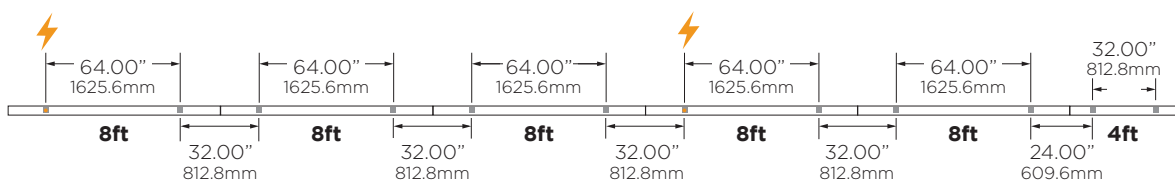

ACCESSORIES

As well as straight runs, Vector can be configured into patterns such as Els, Crosses, Squares, and Tees.

Vector has standard accessories that connect to First, Middle, and End sections which are;

EI

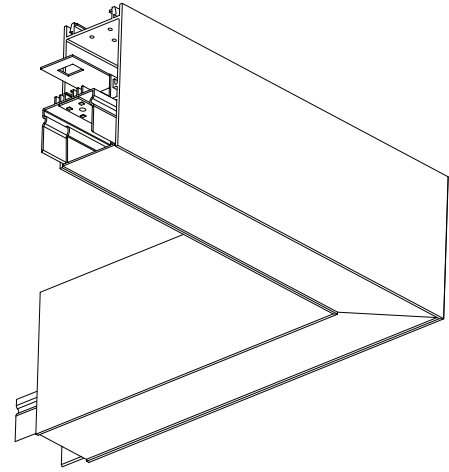
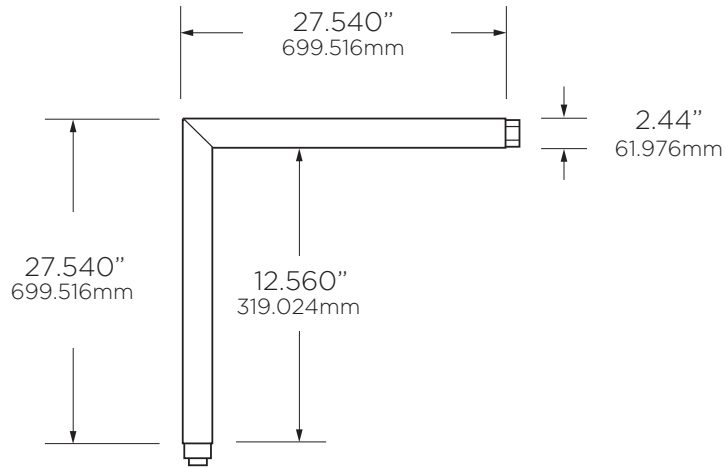

Tee

